

The ILUDEST® Thermal Process Engineering Booklet



AUTO**DEST**®

SPAL**TROHR**®

LABO**DEST**®

FISCHER
technology

FISCHER®
Labor und Verfahrenstechnik

iFISCHER®
a division of ILUDEST

ILUDEST®
Distillation tailor-made



Your requirements are our challenges.

ILUDEST have seen more than 25 years of innovation and progress. Along the way, we have been specialising in the fascinating field of Thermal Process Engineering. Due to the multitude of applications our systems are tailored for and, of course, the high level of our staff's professional qualification, we have become more competent and more successful day by day. Research, development or production - we understand and meet the stringent demands of the chemical, pharmaceutical, biochemical, and environmental industry.



ILUDEST supplies custom distillation plants for any application and any stage, from experimental laboratory work via pilot-plant projects to large-scale processes, with throughput rates ranging from a few ml to 100 l/hr. Combining easy PC operation with state-of-the-art measuring and control electronics has won us a leading position in the field of designing, developing and manufacturing distillation plants.



The merger with our sister company, i-Fischer Engineering, now for the first time enables us to present our entire product range of premium-quality plants and components "Made in Germany" in a single catalogue.

Browse through our catalogue to explore our full range:

It goes without saying that full customisation of each ILUDEST plant is a standard service.

We are ready for the future...

...and to take on the challenges you face.

 Udo Interwies
 Managing Director
 "Engineering"

 Hans Lebahn
 Managing Director
 "Electronics"

 Stefan Opis
 Managing Director
 "Marketing & Sales"

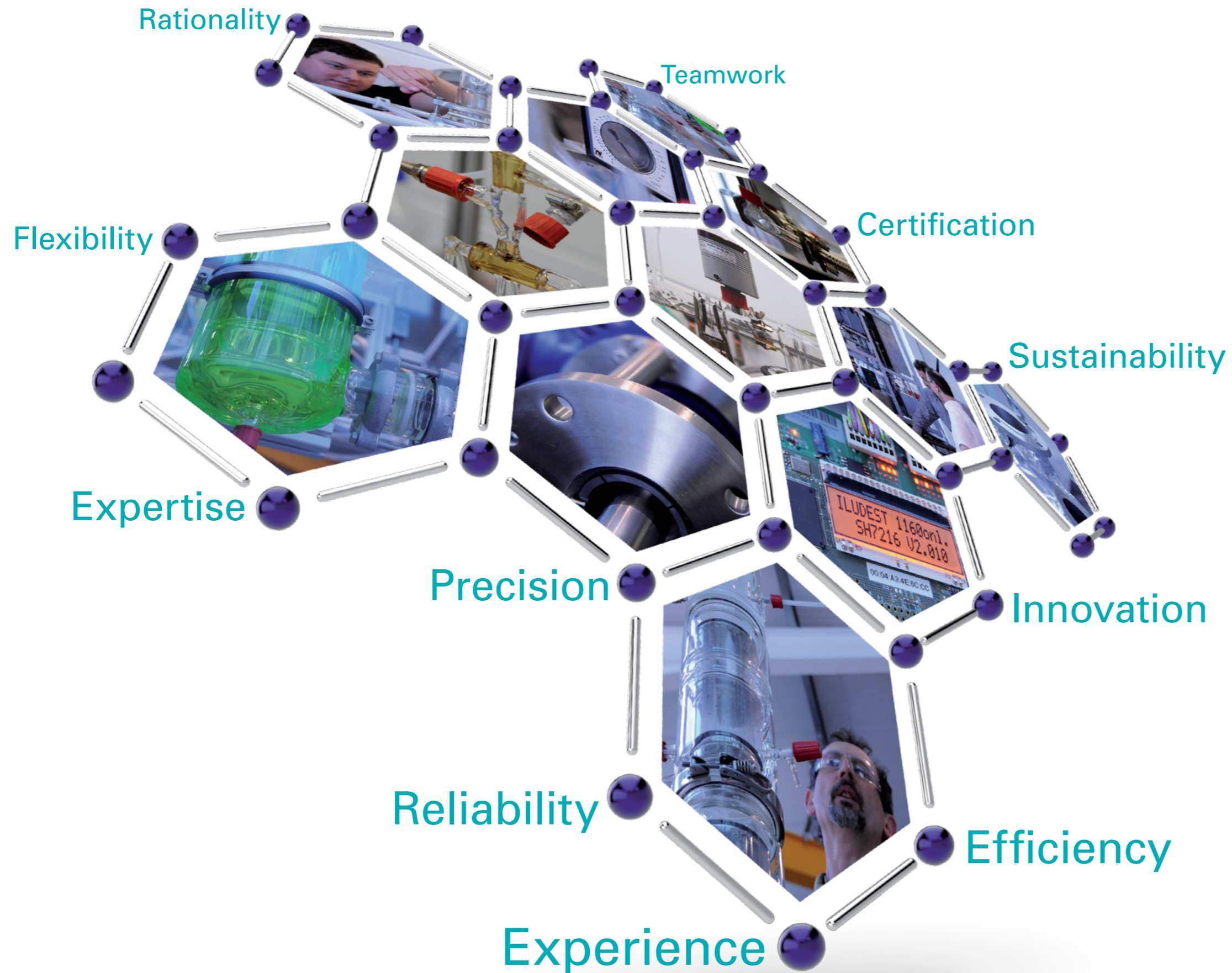

Our formula for your success

We at ILUDEST like to express expertise as the “essence” of something. Our expertise in distillation technology is the essence of what we are and the essence of our performance could be called “precision and customer focus”. Both are central to our customers’ wish to always produce high purity distillates.

Your requirements will always be at the forefront of our approach making each ILUDEST® and i-Fischer® plant a unique high-end product that precisely fulfills our customers’ specific demands and translates challenges into solutions.

The economically dimensioned system for every application

ILUDEST®
Distillation tailor-made

iFISCHER®
a division of ILUDEST

ILUDEST® offers a wide range of products. Our Distillation Plants are designed for extremely flexible service. The following lists a few of many examples:

Chemical industry:

Laboratories, pilot tests, production and training

Petrochemical industry:

Quality assessment of crude oil and its products

Chemical and biological institutes:

Laboratory studies, production and cleaning of chemicals

Universities, technical colleges and vocational schools:

Studies, training and research

Food industry, pharmaceutical industry:

For instance: aromatics

Environmental technology:

Recycling of chlorinated hydrocarbons

i-Fischer Engineering® offers a wide range of products of Process Engineering Systems and Pilot Plants for the Petrochemical Industry:

- Fully or partly Computer Controlled Single or Combined Distillation Systems according to ASTM standards
- Distillation- and Extraction Systems
- Film Evaporator Systems
- Heat Transfer Systems
- Ab-/Desorption Units
- Pilot Plants for Simulating Refinery Towers
- Pilot Plants for Extracting Crude Oils with Light (Deasphalting) and Heavy Solvents
- Reaction Units
- Adiabatic Catalyst Reforming
- Thermal Cracking Micro Reactors
- Pilot Plant Units for Solid-Liquid Extraction
- Delayed Coking and Visbreaking
- Flash Equilibrium
- Ozone Technology

ILUDEST® Process Systems

Distillation Plants for Laboratory and Pilot Plant scale

in borosilicate glass 3.3 or stainless steel, DN 15...700, for continuous or batchwise operation with tray columns or packing material, also explosion-proof, all with "state-of-the-art" computerised control systems

Thin Film Evaporators

DN 25...200, in borosilicate glass 3.3, stainless steel or other metals

Short Path Evaporators

single or multi stage

Reaction Vessels

in borosilicate glass 3.3, stainless steel or steel/glass lined 500 ml to 1,000 ltr, single or completely equipped

Extraction Apparatus

Mixer-Settler
Pulsed column
Soxhlet and other systems

Plants according to ASTM D1160, ASTM D2892 and ASTM D5236

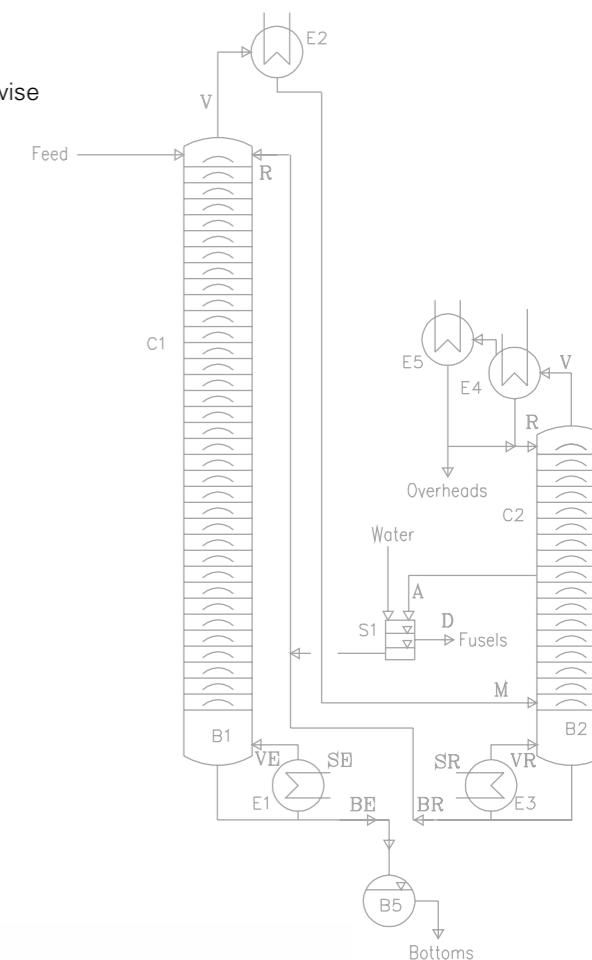



ILUDEST[®]

PORTFOLIO

Process Engineering

Distillation Systems

Process Controllers
for Automated Operation

Single Case Controllers

Solvent Recycling

The introduction of an automated distillation unit, designed by ILUDEST®, is one of the more effective means of improving efficiency. In fact, separations are sometimes so complete that it is often possible to recover solvents whose purity exceeds that of the original, newly-purchased material.

Objections to solvent recycling are usually based on concerns about the adequacy of the recovered product and the expected effort required to complete the distillation. The first concern has been addressed above and we see that, for most clinical applications, very pure materials can be recovered. The work involved in completing a distillation was considerable until the introduction in recent years of automated equipment.

An example of a state-of-the-art distillation apparatus is the ILUDEST® model LM-6/H Computerised Recycling System.

The instrument has a capacity of 6 litres of solvent mixture with a throughput of up to 1 l/hr (e.g. when recovering Xylene). A microcomputer controller holds up to 100 programs as well as monitoring the distillation process for normal and safe operation. Variable reflux ratios and equilibrium times are possible so that the operator has maximum flexibility to design a program for optimal efficiency.

Other capacities are available upon request. Please enquire!

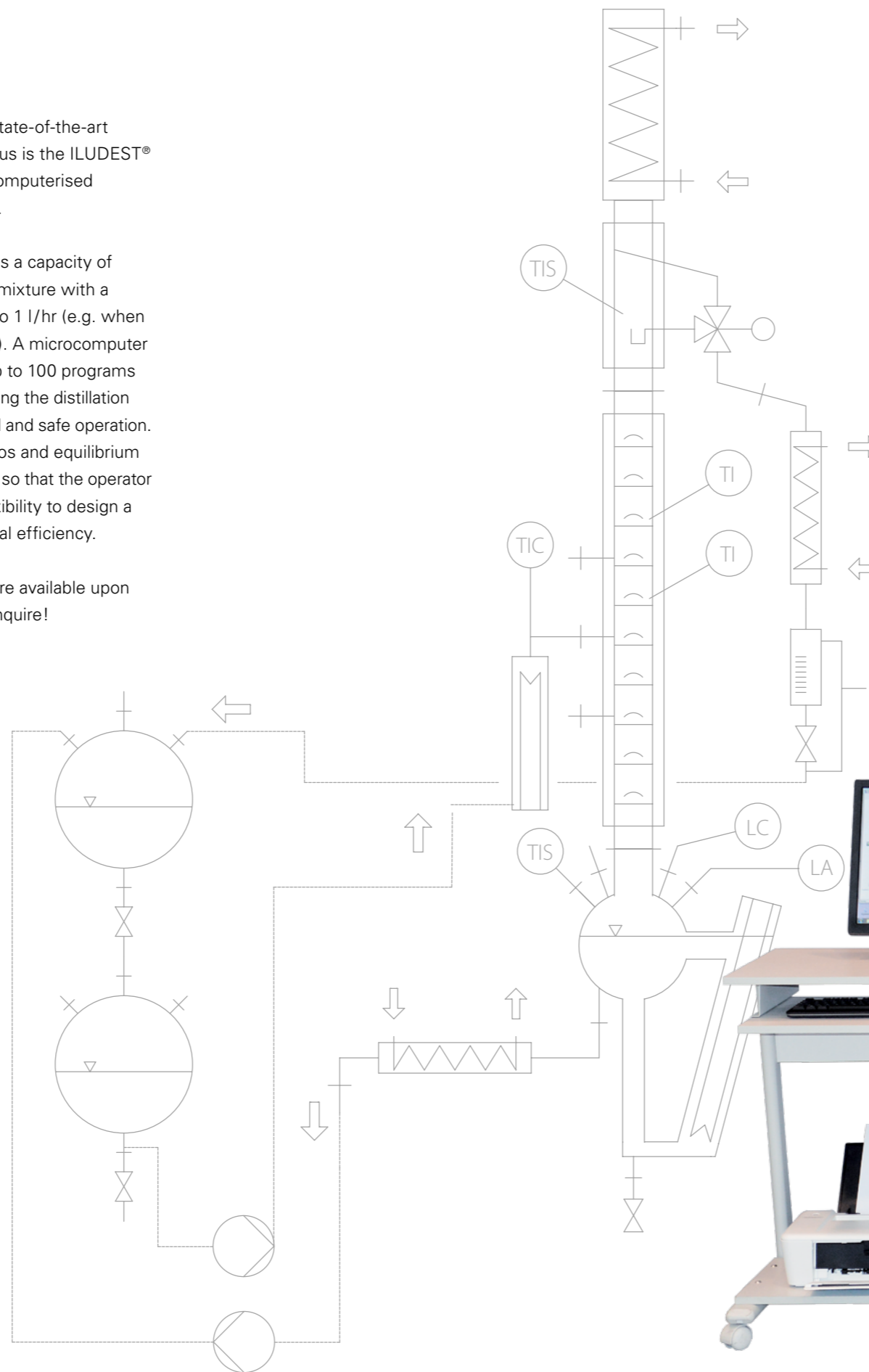

Teaching Units for Thermal Process Engineering

ILUDEST® designs/manufactures a comprehensive range of Teaching Units for the Thermal Process Engineering, e.g.: Continuous Distillation

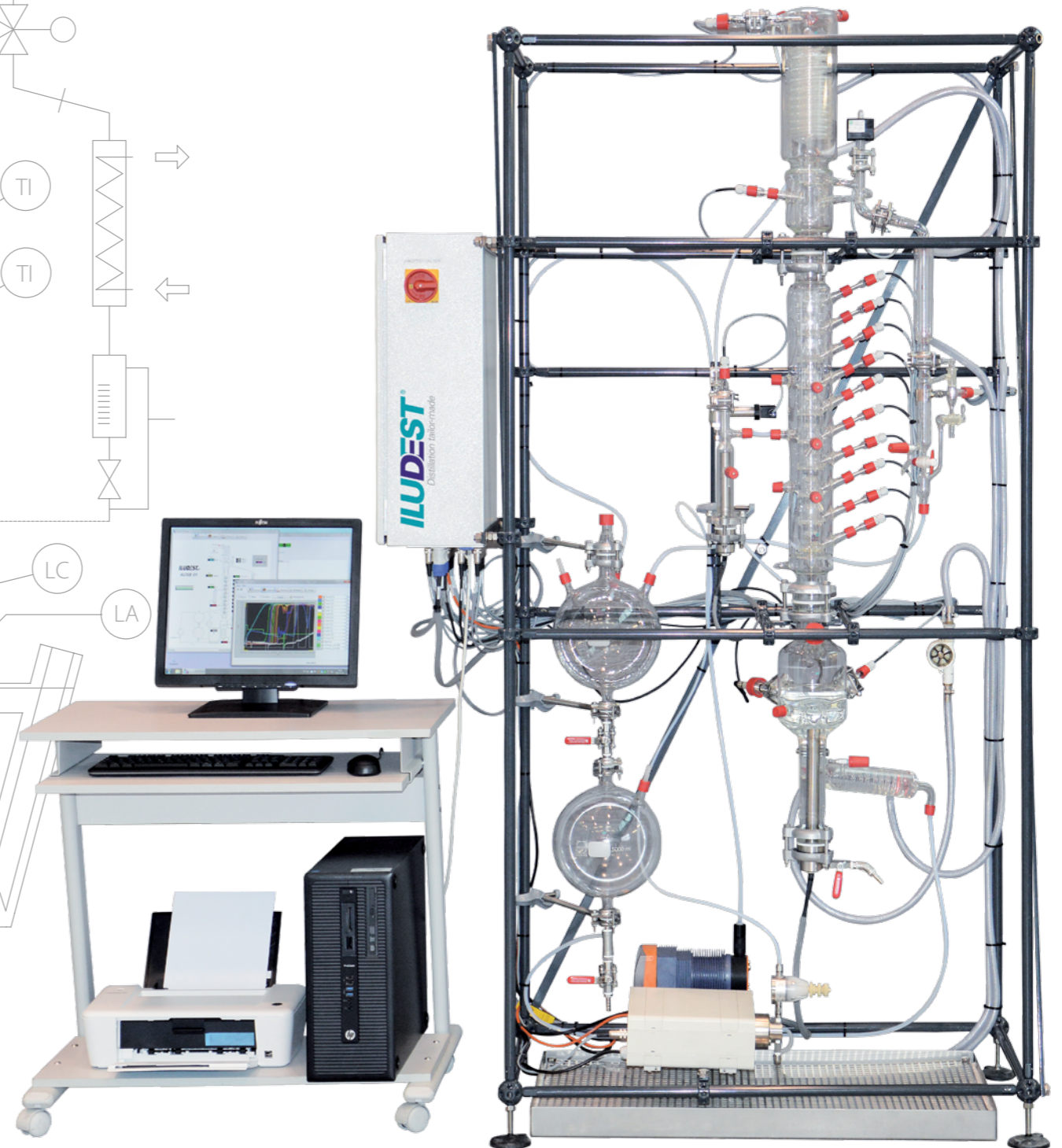

Customised Systems – tailored to your requirements

Highly efficient

Through judicious selection of the appropriate components we achieve best standards of efficiency at high throughput rates.

Operator friendly

Simple and convenient operation of the plant with the highest possible safety standards through the use of hightech electronic measuring and controlling modules.

Operation safe

Temperatures, pressure, filling levels and cooling water as well as utility supply are monitored. We can supply explosion-proof plants or equip plants with safety housings, fire protection troughs and fire extinguishing systems.

Economical

This modern distillation range is noted for its diversity and effectiveness: Distillation components designed as modules for combination and variation according to existing needs. The automatic operation of ILUDEST® plants saves the user unnecessary expenses.

Adaptable

We will match the modular system to your specific problem, irrespective of whether you are working with solvents, aromatics, acids, chlorinated hydrocarbons, petroleum fractions or simply water.

Complete solutions as turn-key jobs

From a round bottom flask with distilling link to the fully automatic, computer controlled pilot plant.



Scale-Down Design

Research Unit
for Alcoholic
Beverage Brands



Distillation System

Reboiler capacity 6,000 ltr/
Column dimension DN 700

Customised Design for
Purification of Essential Oils



ILUDEST Distillation tailor-made
A concept with a future.



Pilot Plant

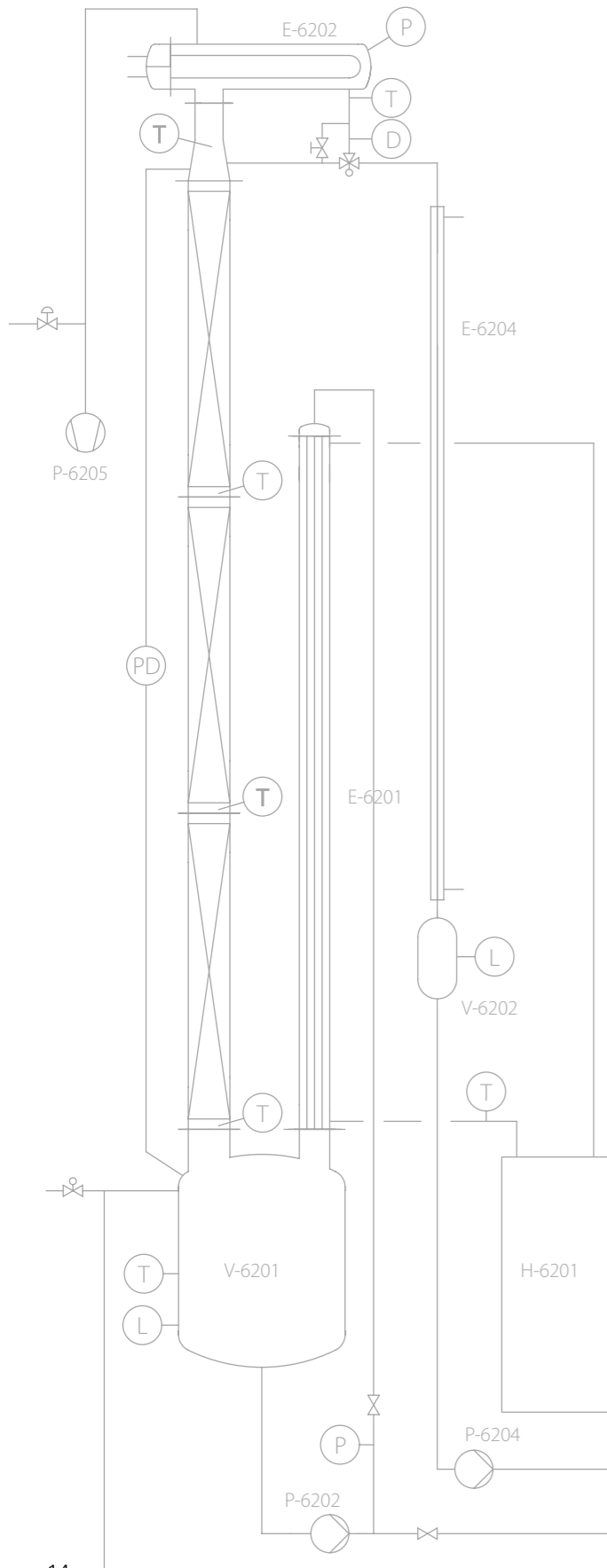

Linear Alpha Olefins Pilot Plant

with Falling Film Evaporator
Reservoir capacity 1,200 ltr
Column Dimension DN 300

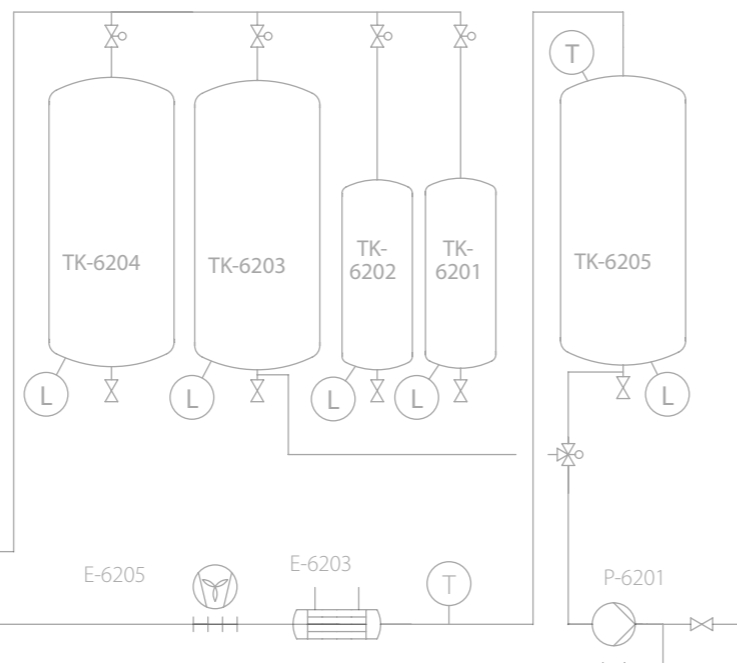

Distillation Control System [DC/MoS]²

ILUDEST® 's PC-based Control System for Fully Automated Operation

The use of a computer-aided system is well suited for the control and regulation of distillation and rectification plants: the wide range of measurement and regulating tasks, the need for flexibility, ease of operation and a display of the operating parameters make the use of a computer with the relevant software and peripherals appear the ideal solution. Particular attention was paid to the following points when developing the regulating system for distillation plants:

- Optimum separating performance by the individual plant thanks to easy adaptability, including changing distillation tasks
- Simple operation through menu control
- Withdrawal of further cuts into separate receivers
- Intermittent operation for getting an optimum in distillate quality and quantity

Process sequences, regulating concepts and algorithms can be altered via the program without the need to intervene via the hardware. The system for controlling distillation and rectification plants comprises the following components:

- Sensors within the plant: resistance thermometers, pressure probes, level probes etc.
- Actuators in the plant: solenoid valves, heating elements, liquid and vacuum pumps, motorised regulating units etc.
- Personal computer and accessories
- ILUDEST® [DC/MoS]² unit as an interface between distillation plant and PC

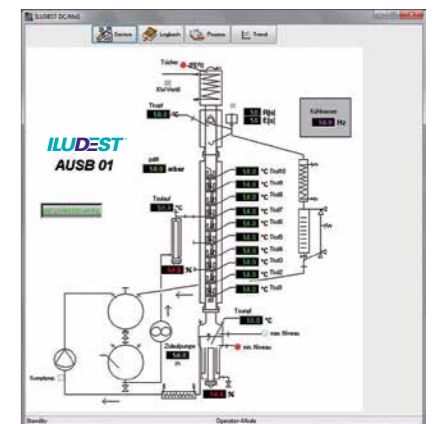
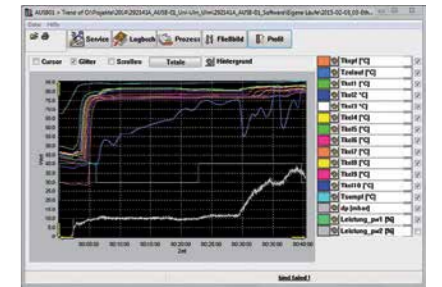

| Schicht | Sammlung | Zufuhr | Zulufluß | AUS | Wiederschlag | Status |
|---------|-------------------|-----------------|----------|-----|--------------|---------|
| 1 | Leitung 40.0 [°C] | Ther. 10.0 [°C] | 0 | 0 | 10.0 | OK |
| 2 | Leitung 40.0 [°C] | Ther. 10.0 [°C] | 0 | 0 | 10.0 | OK |
| 3 | Leitung 30.0 [°C] | Ther. 10.0 [°C] | 0 | 0 | 10.0 | Manuell |

| Schicht | Sammlung | Zufuhr | Zulufluß | AUS | Wiederschlag | Status |
|---------|-------------------|-----------------|----------|-----|--------------|---------|
| 1 | Leitung 40.0 [°C] | Ther. 10.0 [°C] | 0 | 0 | 10.0 | OK |
| 2 | Leitung 40.0 [°C] | Ther. 10.0 [°C] | 0 | 0 | 10.0 | OK |
| 3 | Leitung 30.0 [°C] | Ther. 10.0 [°C] | 0 | 0 | 10.0 | Manuell |

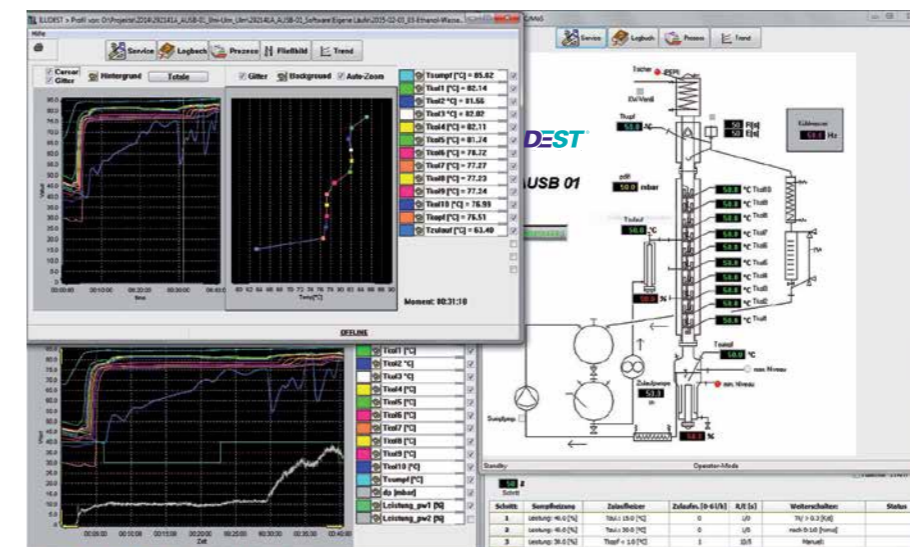

Distillation Control Unit ILUDEST® [DC/MIC]³

ILUDEST®'s answer to medium level requirements on automated distillation controls ...

Unit with colour graphical 15"-Touch-Panel (capacitive) providing the functions as below:

- Heating control either through constant power or constant temperature
- Reflux ratio range (0) 1...500 s/(0) 1...500 s
- Temperature- or time-controlled distribution of fractions by optional fraction valve
- Vacuum control
- Controls of mantle heater
- Numerical and graphical display of all measurement data
- Control of safety limits (temperature and differential pressure)
- Coolant flow control

Automatic Process

- Start-up process at increased heating power
- Equilibrium-time under total reflux
- Fractionation at individual reflux ratio
- Termination of distillation process through maximum temperature
- Minimum level in the evaporator or time-controlled

The controller includes a recipe management

An optional software allows to control the system by a remote PC via Ethernet

In- and outputs for the sensors/actuators (basic design):

- 1x Head solenoid 24VDC max. 1A
- 1x Fraction valve 24VDC max. 1A
- 1x Vacuum valve 24VDC max. 1A
- 1x Cooling water valve bistable
- 1x Alarm output (isolated)
- 2x Heating output each max. 230 V 15A
(please note: total current consumption max. 15A!)
- 1x Output for vacuum pump 230 V max. 4A
- 1x Minimum level sensor input
- 1x Cooling water sensor input
- 1x Optional input
- 1x Head temperature sensor Pt-100
- 1x Flask temperature sensor Pt-100
- 1x Heater temperature sensor Pt-100
- 1x Toption1 Pt-100
- 1x Toption2 Pt-100
- 1x pabs (0...10V)

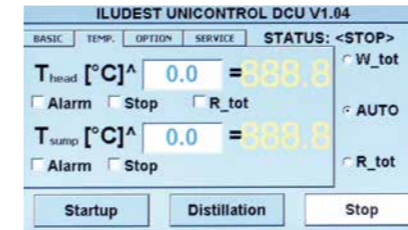
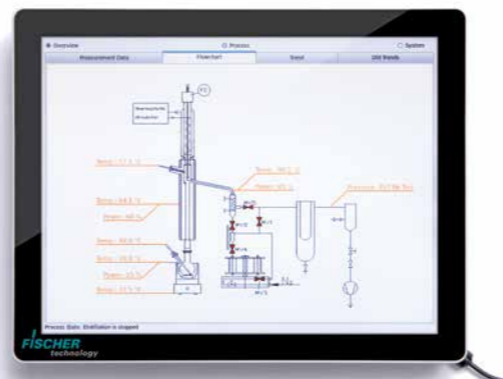
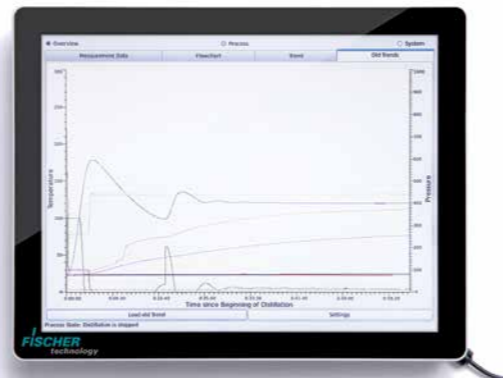
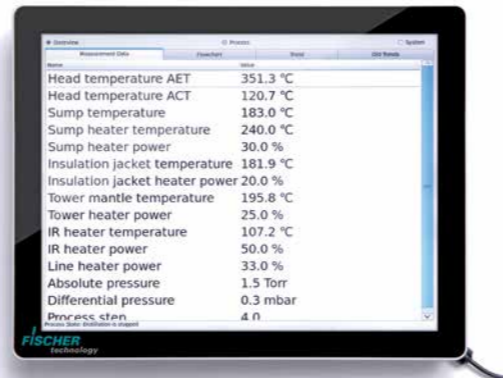

ILUDEST® Single Case Controllers

- [DC/U]³ Distillation Control Unit
- [SU]³ Safety Unit
- [TA]³ Temperature Display
- [VC]³ Vacuum Controller
- [RT]³ Reflux Timer
- [LS]³ Power Controller
- [DP]³ Differential Pressure Controller

Comprehensive range of microprocessor operated units for various control modes/functions. The indication and modification of all set points and actual values is done via touchscreen LCD.

With optional Ethernet interface for the communication with a PC and CAN-BUS for the connection to other controller types.

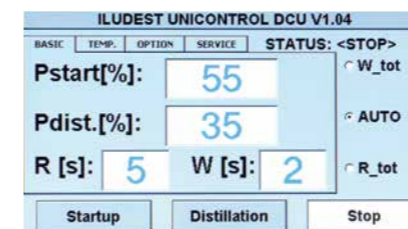



FISCHER[®]

PORTFOLIO

Crude Oil Distillation

Micro-/Semi-Micro Distillation

Phase Equilibrium Apparatuses

Extraction

i-Fischer® DIST D-2892 CC

Fully Computer Controlled Distillation System according to ASTM D2892 (TBP)

For our brand FISCHER technology® this product will be named **FISCHER® AUTODEST® 800 AC**.

The **i-Fischer® DIST D-2892 CC / FISCHER® AUTODEST® 800 AC** is a fully computer controlled unit of turn-key design, and ready for use after installation and commissioning. The system is fully housed and equipped with doors in the front and rear to satisfy safety requirements and to facilitate service aspects.

The automatic fraction collector with 20 receivers includes a built-in internal balance for the determination of the fraction weight, while the separate volume follower system is used for discharging the fractions into the final receivers and the determination of the fraction volume as well as for the direct distillation rate control.

The vacuum equipment and the control system are designed for highest accuracy, repeatability and reproducibility of data.

Also available are the **i-Fischer® DIST D-2892 CC - 100 ltr, 150 ltr, 250 ltr and 500 ltr** fully automated computerised distillation systems acc. to **ASTM D2892** equipped with a set of comprehensive safety features in correlation with the applicable EU Machine Directives and refinery standards. Numerous optional items available.

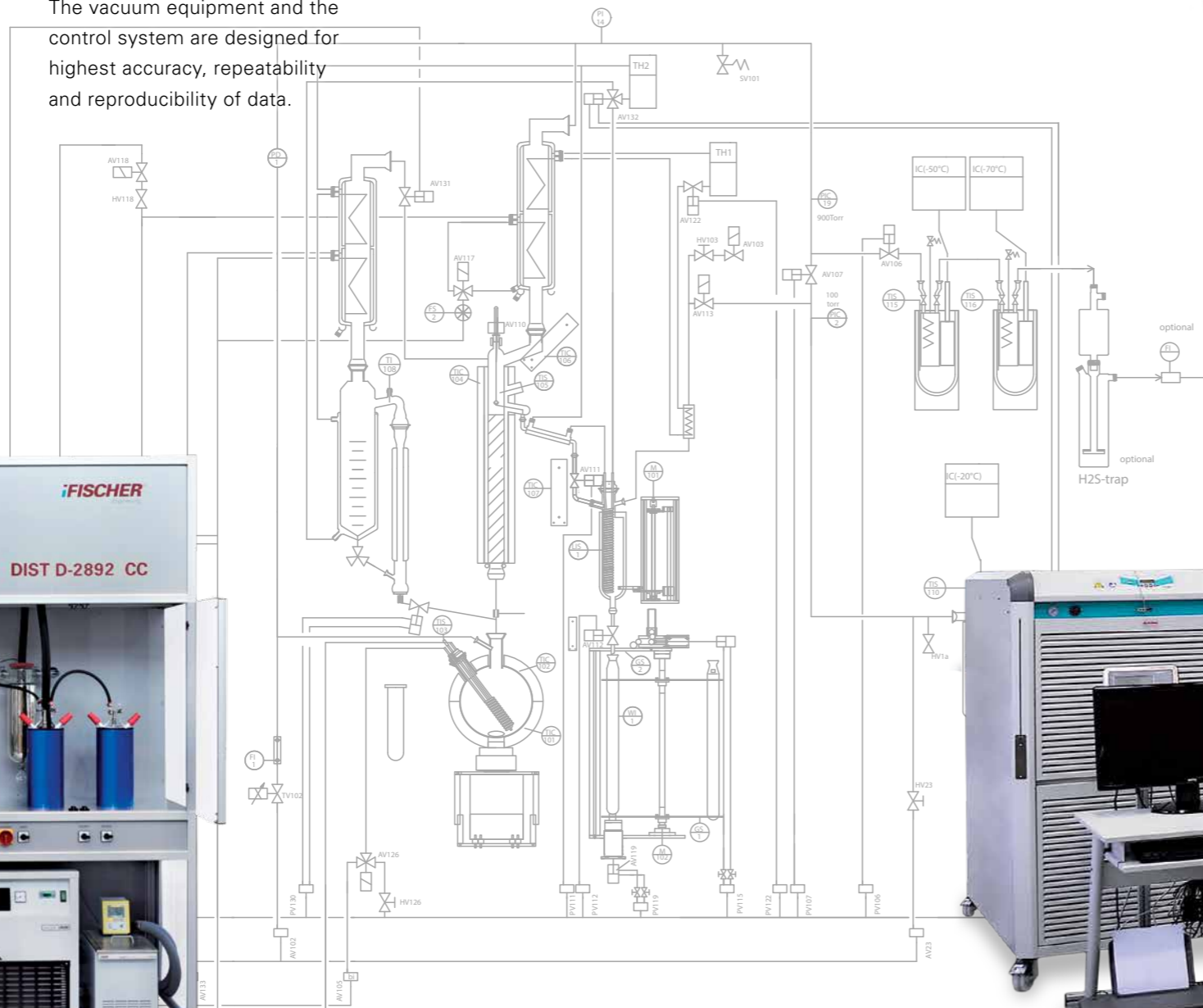

10 ltr. size



250 ltr. size

i-Fischer® DIST D-5236 CC

Fully Computer Controlled Distillation System according to ASTM D5236 (Potstill)

For our brand FISCHER technology® this product will be named **FISCHER® AUTODEST® 860 AC**.

The **i-Fischer® DIST D-5236 CC/ FISCHER® AUTODEST® 860 AC** is a fully computer controlled unit of turn-key design, and ready for use after installation and commissioning. The system is fully housed and equipped with doors in the front and rear to

satisfy safety requirements and to facilitate service aspects.

The automatic fraction collector with 12 receivers includes a built-in internal balance, which is used for the simultaneous determination of the fraction weight and for the direct distillation rate control.

The vacuum equipment and the control system are designed for highest accuracy, repeatability and reproducibility of data.

Also available are the **i-Fischer® DIST D-5236 CC - 50 ltr, 100 ltr, 150 ltr and 250 ltr** fully automated computerised distillation systems acc. to **ASTM D5236** equipped with a set of comprehensive safety features in correlation with the applicable EU Machine Directives and refinery standards. Numerous optional items available.

i-Fischer® DIST D-5236 HV 6 ltr

Fully Computer Controlled Distillation System according to ASTM D5236 (Potstill) with Extension "HV" for High Vacuum Operation up to 620...650°C AET

For our brand FISCHER technology® this product will be named **FISCHER® AUTODEST® 860 HV**.

The **i-Fischer® DIST D-5236 CC/ FISCHER® AUTODEST® 860 AC** can be converted to the "HV"-version by adding an extended Potstill-column

to the standard ASTM-system (Potstill). The respective distillation process is performed in the range of 0.005...0.1 mm Hg.

The **i-Fischer® DIST D-5236 HV 6 ltr/ FISCHER® AUTODEST® 860 HV 6 ltr** is a fully computer controlled unit of turn-key design, and ready for use after installation and commissioning.

The system is fully housed and equipped with doors in the front and rear to satisfy safety requirements and to facilitate service aspects.

The automatic fraction collector with 12 receivers includes a built-in internal balance, which is used for the simultaneous determination of the fraction weight and for the direct distillation rate control. The vacuum equipment and the control system are designed for highest accuracy, repeatability and reproducibility of data.

The **i-Fischer® DIST D-5236 HV 6 ltr/ FISCHER® AUTODEST® 860 HV 6 ltr** is also available with a capacity of up to **50 ltr**.

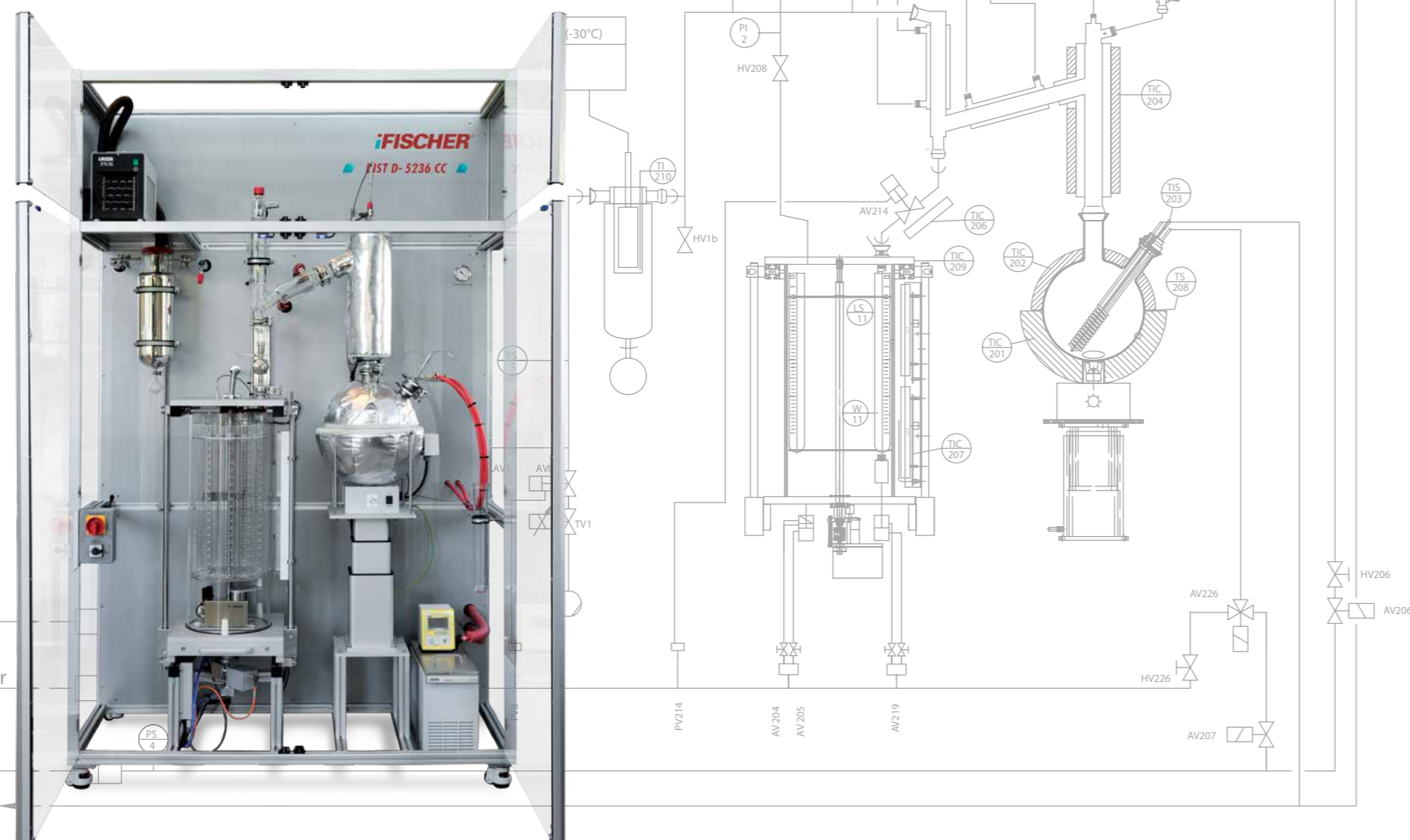

i-Fischer® DIST D-2892/5236 CC

Computer Controlled-Combined Distillation System according to ASTM D2892 (TBP) and ASTM D5236 (Potstill)

For our brand FISCHER technology® this product will be named **FISCHER® AUTODEST® 800/860 AC**. The **i-Fischer® DIST D-2892/5236 CC / FISCHER® AUTODEST® 800/860 AC** is a fully computer

controlled unit of turn-key design, and ready for use after installation and commissioning.

Fully housed and equipped with doors in the front and rear to satisfy safety requirements and to facilitate service aspects.

The automatic fraction collector (in the system section TBP: with 20

receivers) includes a built-in internal balance for the determination of the fraction weight, while the separate volume follower system is used for discharging the fractions into the final receivers and the determination of the fraction volume as well as for the direct distillation rate control.

The automatic fraction collector (in the system section Potstill: with 12 receivers) includes a built-in internal balance, which is used for the simultaneous determination of the fraction weight and for the direct distillation rate control.



i-Fischer® DIST D-2892 MC

Automated Distillation System according to ASTM D2892 (TBP)

For our brand FISCHER technology® this product will be named **FISCHER® AUTODEST® 800 MC**. The **i-Fischer® DIST D-2892 MC / FISCHER® AUTODEST® 800 MC** is an automated, computer controlled

and PC operated unit of turn-key design, ready for use after installation and commissioning. The system is fully housed and equipped with doors in the front and rear to satisfy safety requirements and to facilitate service aspects.

A respective design as per **ASTM D5236 (Postill)** is also available.



i-Fischer® DIST D-1160 CC

Fully Computer Controlled Boiling Analysis according to ASTM D1160

For our brand *FISCHER* technology® this product will be named **FISCHER® AUTODEST® 850 AC**.

The **i-Fischer® DIST D-1160 CC/ FISCHER® AUTODEST® 850 AC** is a fully computer controlled unit of turn-key design, and ready for use after installation and commissioning.

The unit extends the current test method and does not limit your vacuum distillation testing options.

You are able to define your own tailored program also beyond the current standard. The system is fully housed and equipped with doors in the front and rear to satisfy safety requirements and to facilitate service aspects. Design grants an easy maintenance also by the operator.

The analysis protocol is printed out simultaneously to the distillation and the distillation curves in actual boiling temperatures (ACT) and atmospheric equivalent temperatures (AET) as well as essential distillation parameters are shown on the monitor.

The final data and the distillation curves are printed and stored on harddisk.



FISCHER® LABODEST® HMS 500 AC

Automatic Semi-Micro-Distillation-Unit with the FISCHER® SPALTROHR®-Column

Compact and especially versatile, the fully automated **FISCHER® LABODEST® HMS 500 AC** is a unit with highest separation efficiency.

A modular system, which can be designed according to specific requirements including an equipment for recording the distillation curve or for printing-out the distillation record by means of a printer or for connection for electronic data processing.

Technical Data:

- Charge Quantity 10...500 ml
- Operation Temperature up to 200°C respectively up to 350°C
- Operation Pressure Atmospheric or Vacuum 100...0.1 mbar
- Pressure Drop < 0.1 mbar
- Separation Efficiency up to 90 theoretical plates
- Mains Supply 230 V, 50 Hz
- Dimensions (w x d x h) 1.25 x 0.60 x 1.70 m
- Weight approx. 100 kg



FISCHER® LABODEST® VLE/VLLE 602 Vapour-Liquid-(Liquid)-Equilibrium-Determination from vacuum up to overpressure

Scientists and chemical engineers in industry, research and teaching still measure phase equilibria despite the significant improvement in theoretical evaluations.

For that reason, the **FISCHER®** phase equilibrium apparatus is part of the standard equipment in chemical engineering laboratories.

The vapour-liquid equilibrium of binary and multi-component mixtures constitute an essential basis for the determination of the theoretical plates necessary for the evaluation of separation processes.

Although VLE-data are known from literature, there is still an increasing tendency towards redetermining equilibrium data by experiments, because the thermodynamic parameters like pressure, temperature and concentrations are different or inadequate.

For designing e.g. extractive-distillation processes the evaluation of vapour-liquid-liquid phase equilibria (VLLE-data) are required. The practical measurement and determination of these data proves difficult with the standardised VLE-units because of the phase formation of the liquids.

ILUDEST®/i-Fischer® collaborates closely under an exclusive license with the University of Alicante (Spain) and adapted their patented scientific idea (ES 2 187 220 B2) to create a VLLE device design suitable for serial production.

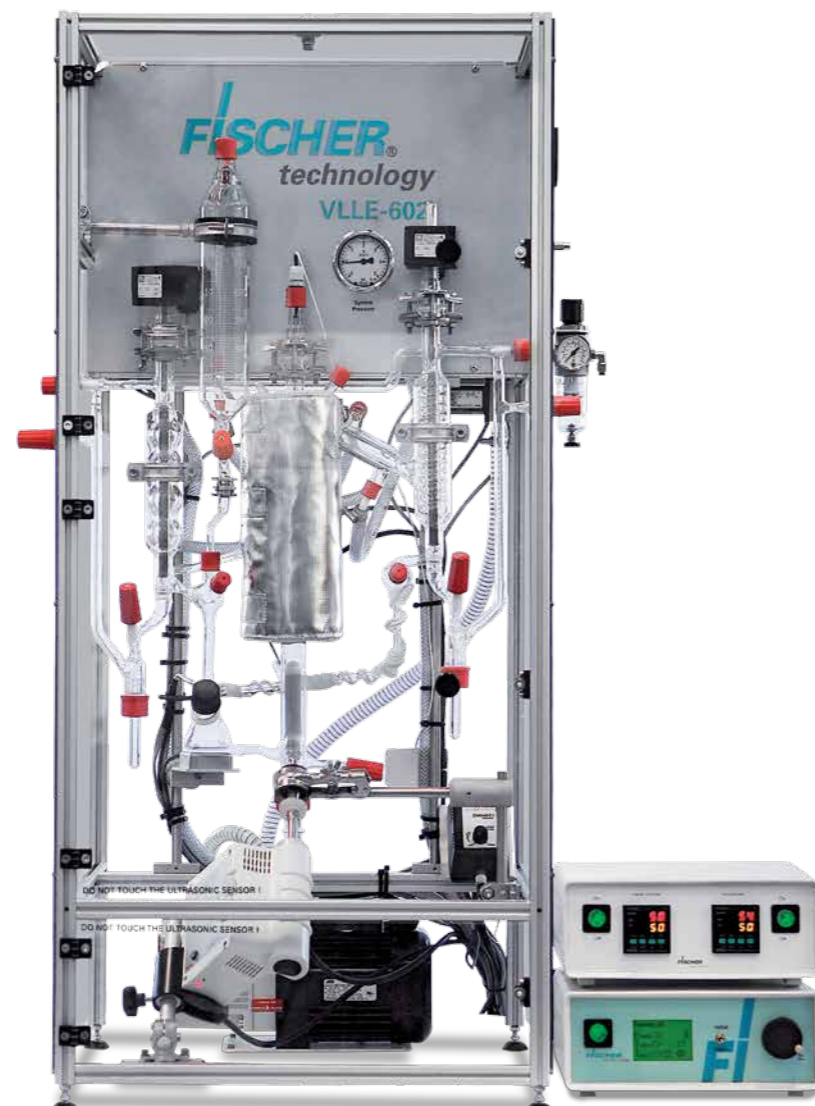

FISCHER® LABODEST® VLE 602/50 Vapour-Liquid-Equilibrium-Determination from vacuum (1 mbar) up to overpressure (50 bar)

Scientists and chemical engineers in industry, research and teaching still measure phase equilibria despite the significant improvement in theoretical evaluations.

For that reason, the **FISCHER®** phase equilibrium apparatus is part of the standard equipment in chemical engineering laboratories.

The vapour-liquid equilibrium of binary and multi-component mixtures constitute an essential basis for the determination of the theoretical plates necessary for the evaluation of separation processes. Although VLE-data are known from literature, there is still an increasing tendency towards redetermining equilibrium data by experiments, because the thermodynamic parameters like pressure, temperature and concentrations are different or inadequate.

Especially the theoretically additional evaluation of the temperature and pressure dependence of phase equilibrium is insufficient very often in daily practice, thus the experimental determination of VLE-data is increasingly requested in the overpressure range, too.

ILUDEST/i-Fischer modified the VLE-equipment, since decades sold

under the world-known **FISCHER®**-brand, suitable for the overpressure range up to 50 bar.

The VLE-equipment is designed for a charge of 50 ml (dynamic mode) and can be operated under vacuum (1...1,013 mbar), atm-condition and overpressure (1...50 bar) as well as temperature up to 180°C.

An extended operating range up to 100 bar is possible.

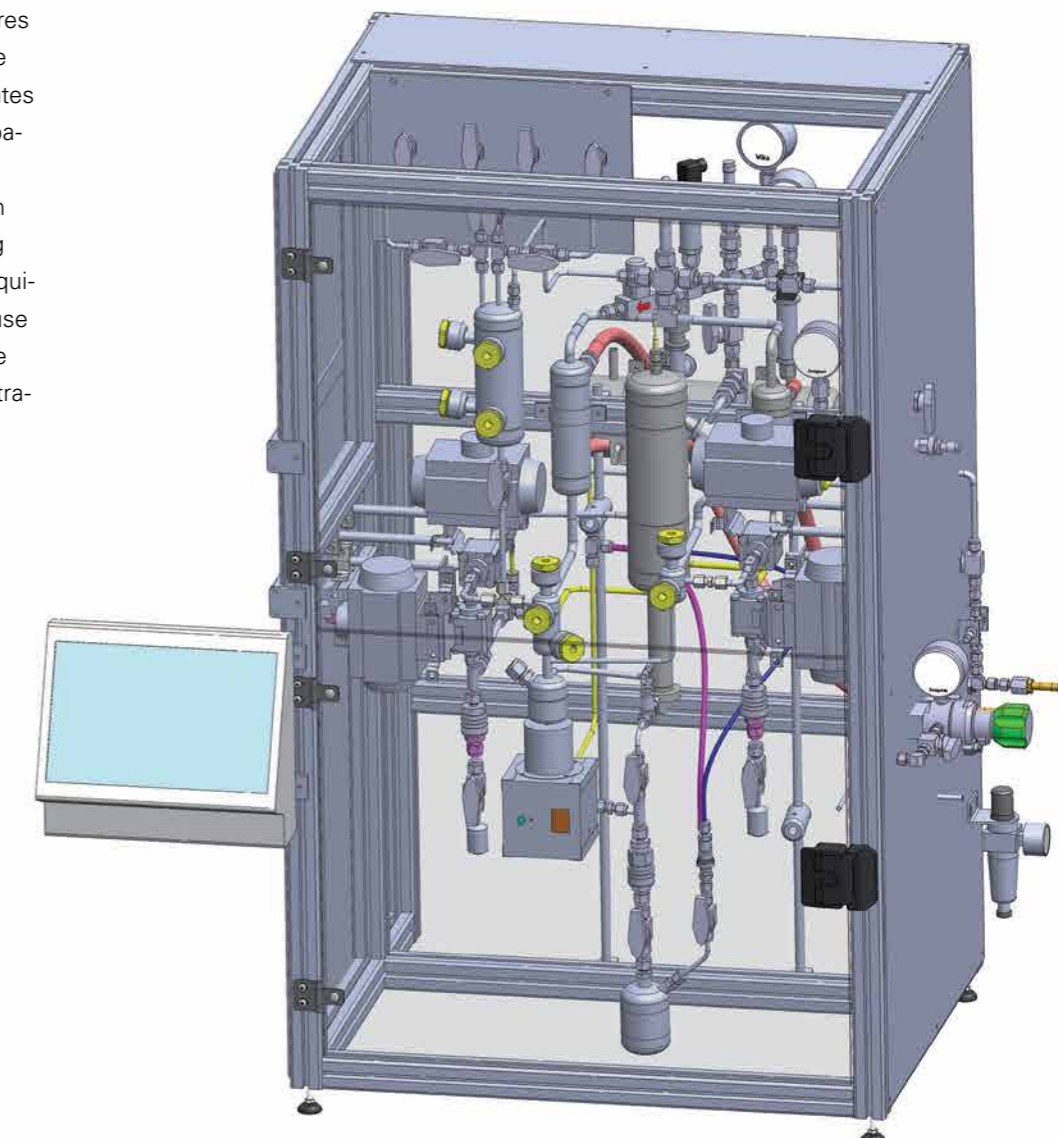

FISCHER® EMS - 250/SR

Laboratory Mixer/Settler - Extractor

For liquid-liquid-extraction according to the Mixer-Settler-principle, design acc. to Dr. E. Müller (Lurgi).

With screw stirrer for intensive mixing of the phases, especially suited for metallic salt extraction. Pumping capacity and residence times are changed by adjusting the stirrer speed. An additional advantage of the unit is the application for extractions during which reactions of considerable density changes occur.

Typical applications for this universal apparatus are:

- metal salt extractions
- mixtures with low surface tension
- if the dispersed phase coalesces with difficulty
- if variation in residence time of the phases occur in the extraction stages
- if reactions are expected during the extraction process
- if considerable changes in density are expected as a result of extraction

Extraction parameters determined by this unit can be scaled up.

All parts in contact with the product are made of glass and PTFE. Once adjusted, the Mixer-Settler Extractor works maintenance-free and can be switched on or off without changing the hydrodynamic conditions.

Technical Data:

- Total Throughput
max. 5 l/h
- Throughput per Phase
0.1...2.5 l/h
- Settler Volume
250 ml
- Number of Stages
max. 10
- Stage Efficiency
approx. 95%
- Wetted parts
borosilicate glass 3.3, PTFE
- Mains Supply
230 V, 50...60 Hz
- Dimensions (L x D x H)
approx. 1,250 x 1,000 x 1,500 mm
(10 stages)

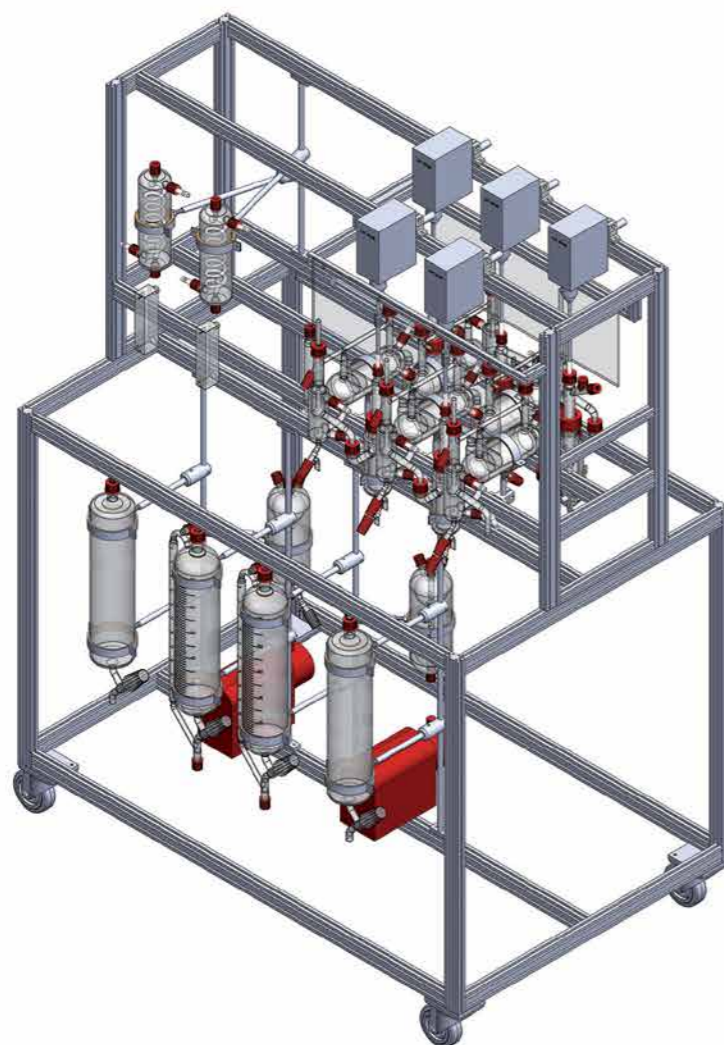

The apparatus / plant meeting your particular demand is not appearing in this booklet?

Talk to us and let us know about your requirements ...



ILUDEST Destillationsanlagen GmbH
Dachdeckerstr. 1
97297 Waldbüttelbrunn
Germany

Tel.: +49 (0) 931 497 090
Fax: +49 (0) 931 404 209 9
E-mail: info@iludest.de
www.iludest.de

